

11/00/01/17/20

# **OWNER'S MANUAL**

## **Gasoline Generator**



## TABLE OF CONTENTS

<b>GENERAL SAFETY PROCEDURES</b> .....	1
<b>GENERATOR COMPONENTS</b> .....	3
<b>PREPARING THE GENERATOR FOR USE</b> .....	4
Using the Generator for the First Time .....	4
Step 1- Add oil .....	4
Step 2- Add Gasoline.....	4
Step 3- Ground the Generator .....	5
Subsequent Use of the Generator .....	6
Step 1- Check the Oil .....	6
Step 2- Check the Gas Level .....	6
Step 3- Ground the Generator .....	7
<b>STARTING THE GENERATOR</b> .....	8
<b>USING THE GENERATOR</b> .....	9
<b>STOPPING THE GENERATOR</b> .....	12
<b>MAINTENANCE / CARE</b> .....	12
Cleaning the Generator.....	13
Checking the Oil.....	14
Changing/ Adding Oil .....	14
Air Cleaner Maintenance .....	14
Fuel Filter Cup Cleaning .....	15
Spark Plug Maintenance.....	15
Emptying the Gas Tank.....	16
<b>STORAGE/TRANSPORT PROCEDURES</b> .....	16
<b>SPECIFICATIONS</b> .....	17
<b>TROUBLESHOOTING</b> .....	18

### NOTICE REGARDING EMISSIONS

Engines that are certified to comply with U.S. EPA emission regulations for SORE (Small Off Road Equipment), are certified to operate on regular unleaded gasoline.



## GENERAL SAFETY PROCEDURES

Please familiarize yourself with the following safety symbols and words:

The safety alert symbol  is used with one of the safety words (**DANGER**, **WARNING**, or **CAUTION**) to alert user to hazards. Please pay attention to these hazard notices both in this manual and on the generator.

**DANGER:** Indicates a hazard that will result in serious injury or death if instructions are not followed.

**WARNING:** Indicates a strong possibility of causing serious injury or death if instructions are not followed.

**CAUTION:** Indicates a possibility of personal injury or equipment damage if instructions are not followed.

 **DANGER: POISONOUS GAS.** Generators give off carbon monoxide, a poisonous gas that can kill you quickly. You **CANNOT** smell it, see it, or taste it.

- **ONLY** run generator outdoors and away from air intakes, open windows, and garages.
- Never use inside homes, garages, or sheds, **EVEN IF** you run a fan or open doors and windows.

If you start to feel sick, dizzy, or weak while using the generator, shut it off and get to fresh air **RIGHT AWAY**. See a doctor. You may have carbon monoxide poisoning.

 **WARNING:** The exhaust from this product contains chemicals known to the State of California to cause cancer, birth defects, or other reproductive harm.

 **WARNING:** This generator may emit highly flammable and explosive gasoline vapors, which can cause severe burns or even death. A nearby open flame can lead to explosion even if not directly in contact with gas.

- Do not operate near open flame.
- Do not smoke near generator.
- Always operate on a firm, level surface.
- Always turn generator off before refueling. Allow generator to cool for at least 2 minutes before removing fuel cap. Loosen cap slowly to relieve pressure in tank.
- Do not overfill gas tank. Gas may expand during operation. Do not fill to the top of the tank.
- Always check for spilled gas before operating.
- Empty gasoline tank before storing or transporting the generator.
- Before transporting, turn fuel valve to off and disconnect spark plug.

**⚠ WARNING:** This generator produces powerful voltage, which can result in electrocution.

- ALWAYS ground the generator before using it (see the "Ground the Generator" portion of the "PREPARING THE GENERATOR FOR USE" section).
- Generator should only be plugged into electrical devices, either directly or with an extension cord. NEVER connect to a building electrical system without a qualified electrician. Such connections must comply with local electrical laws and codes. Failure to comply can create a backfeed, which may result in serious injury or death to utility workers.
- Use a ground fault circuit interrupter (GFCI) in highly conductive areas such as metal decking or steel work. GFCIs are available in-line with some extension cords.
- Do not use in rainy or wet conditions.
- Do not touch bare wires or receptacles (outlets).
- Do not allow children or non-qualified persons to operate.

**⚠ WARNING:** Never connect a generator directly to any existing electrical building circuit. The generator can backfeed into power lines and electrocute nearby electrical repair workers.

**⚠ WARNING:** This generator produces heat when running. Temperatures near exhaust can exceed 150° F (65° C).

- Do not touch hot surfaces. Pay attention to warning labels on the generator denoting hot parts of the machine.
- Allow generator to cool several minutes after use before touching engine or areas which heat during use.

**⚠ CAUTION:** Misuse of this generator can damage it or shorten its life.

- Use generator only for its intended purposes.
- Operate only on dry, level surfaces.
- Allow generator to run for several minutes before connecting electrical devices.
- Shut off and disconnect any malfunctioning devices from generator.
- Do not exceed the Wattage capacity of the generator by plugging in more electrical devices than the unit can handle.
- Do not turn on electrical devices until *after* they are connected to the generator.
- Turn off all connected electrical devices before stopping the generator.

## GENERATOR COMPONENTS

Please familiarize yourself with the locations and functions of the various components and controls of this generator.

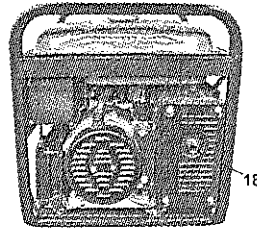
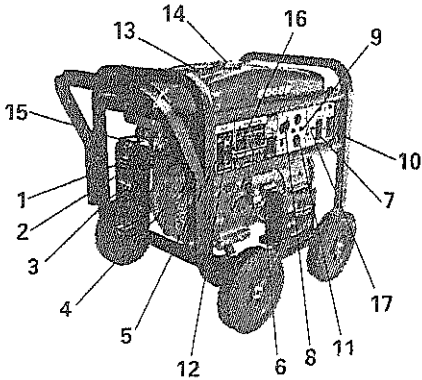

- (1) **Air Cleaner**- A removable, cleanable, sponge-like element that limits the amount of dirt pulled into the engine.
- (2) **Fuel Valve**- Allows fuel to enter engine.
- (3) **Fuel Filter Cup**- Traps dirt and water from fuel before it enters the engine.
- (4) **Recoil Starter**- Pull-cord for starting engine.
- (5) **Engine Switch**- To start/stop engine.
- (6) **Oil Fill and Dipstick**- Location for checking and filling engine oil.
- (7) **120 Volt AC GFCI Receptacles**- To connect electrical devices that run 120 Volt, 60 Hz, single phase, AC current.
- (8) **Voltage Selector**-To switch between 120 and 240 Volt output.
- (9) **Circuit Reset Buttons**- Reset buttons that protect the generator from electrical overload.
- (10) **Ground Terminal**- Connect grounding wires here to properly ground unit.
- (11) **120/240 Volt AC Receptacle**- To connect electrical devices that run 120 and/or 240 Volt, 60 Hz, single phase, AC current.
- (12) **Pilot Light**-Red lights that turn on to indicate the output of power to each receptacle.
- (13) **Fuel Gauge**- Indicates the amount of fuel in the tank.
- (14) **Fuel Cap**- Access to the fuel tank for adding fuel
- (15) **Choke Lever**- Adjusts the amount of air let into the engine.
- (16) **Idle Switch (Optional)** -To start/stop idle control system.
- (17) **Circuit Breaker**-To protect the generator from short current.
- (18) **Muffler**- Reduces engine noise.

## PREPARING THE GENERATOR FOR USE

### Using the Generator for the First Time

If you are using the generator for the first time, there are a few steps you must take to prepare it for operation:

#### *Step 1- Add oil*

The generator requires engine oil to operate properly. The new generator fresh from the package contains *no* oil in the crankcase. User must add the proper amount of oil before operating the generator for the first time. The oil capacity of this engine crankcase is 37 fluid oz. For general use, we recommend 30W, 4-stroke engine oil to fill the engine crankcase.

To add oil, follow these steps:

1. Make sure the generator is on a level surface
2. Unscrew the oil filler/dipstick cap from the engine as shown in figure 1.
3. Using a funnel, add the appropriate amount of oil into the crankcase. The crankcase is full when the oil level has reached the lower lip of the opening where you have just poured the oil into (see figure 2).
4. Reinstall oil filler cap.

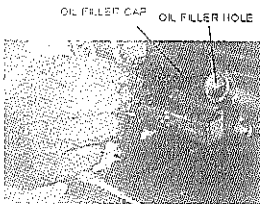

Figure 1- Unscrewing the oil cap

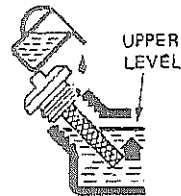

Figure 2- Adding oil

#### *Step 2- Add Gasoline*

**⚠ WARNING:** Gasoline and gas fumes are highly flammable. A nearby open flame can lead to explosion even if not directly in contact with gas.

- Do not operate near open flame.
- Do not smoke near generator.
- Always operate on a firm, level surface.
- Always turn generator off before refueling. Allow generator to cool for at least 2 minutes before removing fuel cap. Loosen cap slowly to relieve pressure in tank.
- Do not overfill gas tank. Gas may expand during operation. Do not fill to the top of the tank.



- Always check for spilled gas before operating.
- Empty gasoline tank before storing or transporting the generator.
- Before transporting, turn fuel valve to off and disconnect spark plug.

To ensure that the generator runs smoothly use only FRESH, UNLEADED GAS WITH AN OCTANE RATING OF 87 OR HIGHER. To add gasoline:

1. Make sure the generator is on a level surface.
2. Unscrew gas cap and set aside (NOTE: the gas cap may be tight and hard to unscrew).
3. Slowly add unleaded gasoline to the fuel tank. Be careful not to overfill. The capacity of the gas tank is 8.5 gallons (32L—8000E) or 12 gallons (46L—10000E). NOTE: Gas can expand. Do not fill the gas tank to the very top.
4. Replace fuel cap and wipe up any spilled gasoline with a dry cloth.

**IMPORTANT:**

- Never use an oil/gasoline mixture.
- Never use old gas.
- Avoid getting dirt or water in the fuel tank.
- Gas can age in the tank and make it hard to start up the generator in the future. Never store generator for extended periods of time with fuel in the tank.

**Step 3- Ground the Generator**

**▲ WARNING:** Failure to properly ground the generator can result in electrocution.

Ground the generator by tightening the grounding nut against a grounding wire (see figure 3). A generally acceptable grounding wire is a No. 12 AWG (American Wire Gauge) stranded copper wire. This grounding wire should be connected at the other end to a copper or brass grounding rod that is driven into the earth.

Grounding codes can vary by location. Please contact a local electrician to check the grounding regulations for your area.

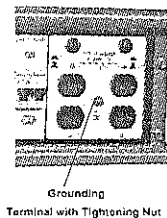

Figure 3- Grounding nut location

**Subsequent Use of the Generator**

If this is not your first time using the generator there are still steps you should take to prepare it for operation.

**IMPORTANT:** At this point you should be familiar with the procedures described in the first portion of this section entitled “Using the Generator for the First Time.” If you have not yet read this section, go back and read it now.

### *Step 1- Check the Oil*

The generator is equipped with an automatic low oil shutoff to protect it from damage. Nonetheless, user should check the oil level of the engine before each use to ensure that the engine crankcase contains sufficient lubricant. To check the oil level:

1. Make sure the generator is on a level surface.
2. Unscrew the oil filler/dipstick cap.
3. With a dry cloth, wipe the oil off the stick on the inside of the cap.
4. Insert the dipstick as if you were replacing the cap and then remove again. There should now be oil on the stick. If there is no oil on the stick, or oil only at the very end of the stick, you should add oil until the engine crankcase is filled (see “Changing/Adding Oil” portion of the “Maintenance” section).
5. Be sure to replace cap when finished checking oil.

NOTE: The oil capacity for this generator is 37 fluid oz.

### *Step 2 – Check the Gas Level*

Before starting the generator, check to see that there is sufficient gasoline in the gas tank. The fuel gauge on top of the generator will indicate the gas level in the tank. Add gas if necessary.

**⚠ WARNING: Gasoline and gasoline fumes are highly flammable.**

- Do not fill tank near an open flame.
- Always allow engine to cool for several minutes before refueling.
- Do not overfill (check the “Specifications” section for the tank capacity of this generator). Always check for fuel spills.

**IMPORTANT:**

- Use only UNLEADED gasoline with an octane rating of 87 or higher.
- Do not use old gas.
- Never use an oil/gasoline mixture.
- Avoid getting dirt or water in the fuel tank.
- Never store generator for extended periods of time with fuel in the tank.

### *Step 3- Ground the Generator*

**⚠ WARNING: Failure to properly ground the generator can result in electrocution.**

Ground the generator by tightening the grounding nut against a grounding wire (see figure 3). A generally acceptable grounding wire is a No. 12 AWG (American Wire Gauge) stranded copper wire. This grounding wire should be connected at the other end to a copper or brass grounding rod that is driven into the earth.

Grounding codes can vary by location. Please contact a local electrician to check the grounding regulations for your area.

## STARTING THE GENERATOR

**⚠ DANGER: POISONOUS GAS.** Generators give off carbon monoxide, a poisonous gas that can kill you quickly. You CANNOT smell it, see it, or taste it.

- ONLY run generator outdoors and away from air intakes, open windows, and garages.
- Never use inside homes, garages, or sheds, EVEN IF you run a fan or open doors and windows.

If you start to feel sick, dizzy, or weak while using the generator, shut it off and get to fresh air RIGHT AWAY. See a doctor. You may have carbon monoxide poisoning.

**⚠ WARNING: This generator produces powerful voltage, which can result in electrocution.**

- ALWAYS ground the generator before using it (see the “Ground the Generator” portion of the “PREPARING THE GENERATOR FOR USE” section).
- Generator should only be plugged into electrical devices, either directly or with an extension cord. NEVER connect to a building electrical system without a qualified electrician. Such connections must comply with local electrical laws and codes. Failure to comply can create a backfeed, which may result in serious injury or death to utility workers.
- Use a ground fault circuit interrupter (GFCI) in highly conductive areas such as metal decking or steel work. GFCIs are available in-line with some extension cords.
- Do not use in rainy or wet conditions.
- Do not touch bare wires or receptacles (outlets).

Do not allow children or non-qualified persons to operate.

**⚠ CAUTION: Disconnect all electrical loads from the generator before attempting to start.**

To start your generator, perform the following steps:

1. Make sure no electrical devices are connected to the generator. Such devices can make it difficult for the engine to start.
2. Check that the generator is properly grounded (see “Ground the Generator”).
3. Turn the fuel valve to the “on” position (see figure 4).
4. Move the choke lever to the “closed” position (see figure 5).
5. Set the engine switch to the “on” position.
6. (Optional: Set the idle switch to the “on” position.)

7. Pull on the recoil starter handle slowly until a slight resistance is felt (see figure 6). Then pull quickly to start the engine. Return cord gently into the machine. Never allow the cord to snap back.
8. If engine fails to start, repeat step 6. NOTE: After repeated failed attempts to start the engine, please consult the troubleshooting guide before attempting again.
9. Once the engine has started move the choke lever about half way towards the “open” position. Wait 30 seconds and then move the choke lever all the way to the “open” position.
10. Allow the generator to run for several minutes before attempting to connect any electrical devices.

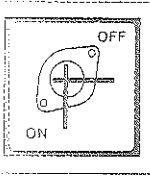

Figure 4- Fuel valve positions



or

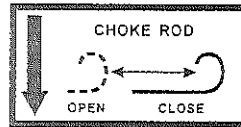

Figure 5- Choke positions

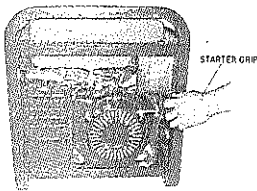

Figure 6- Pulling the start cord

## USING THE GENERATOR

**⚠ WARNING:** Never connect a generator directly to any existing electrical building circuit. The generator can backfeed into power lines and electrocute nearby electrical repair workers.

Once you have allowed the engine to run for several minutes, you may connect electrical devices to the generator.

**⚠ CAUTION:** Please familiarize yourself with the markings on the panel before connecting electrical devices.

You may connect electrical devices running on AC current according to their wattage requirements. The chart in figure 7 shows the rated and surge wattage of your generator.

The *rated wattage* corresponds to the rated wattage the generator can output on a continuous basis.

Rated (Running) Wattage
5500
5500
7000

Figure 7- generator wattage.

The total running wattage requirement of the electrical devices connected to the generator should not exceed the rated wattage of the generator itself. To calculate the total wattage requirement of the electrical devices you wish to connect, find the rated (or running) wattage of each device. This number should be listed somewhere on the device or in its instruction manual. If you cannot find this wattage, you may calculate it by multiplying the Voltage requirement by the Amperage drawn:

$$\text{Watts} = \text{Volts} \times \text{Amperes}$$

If these specifications are not available you may estimate the Watts required by your device by using the chart in figure 8.

Once you have found the rated wattage requirement of each electrical device, add these numbers to find the total rated wattage you wish to draw from the generator. If this number exceeds the rated wattage of the generator, **DO NOT** connect all these devices. Select a combination of electrical devices, which has a total rated wattage lower than or equal to the rated wattage of the generator.

**⚠ CAUTION-** The generator can run at its surge wattage capacity for only a short time. Connect electrical devices requiring a rated (running) wattage equal to or less than the rated wattage of the generator. Never connect devices requiring a rated wattage equal to the surge wattage of the generator.

tool or appliance	rated (running) Watts	additional surge Watts
electric water heater (40 gal)	4000	0
hot plate	2500	0
saw- radial arm	2000	2000
electric stove	1500	0
saw- circular	1500	1500
air compressor (1 HP)	1500	3000
window air conditioner	1200	1800
saw- miter	1200	1200
microwave	1000	0
well water pump	1000	1000
reciprocating saw	960	1040
sump pump	800	1200
refrigerator freezer	800	1200
furnace blower	800	1300
computer	800	0
electric drill	600	900
television	500	0
deep freezer	500	500
garage door opener	480	0
stereo	400	0
box fan	300	600
clock radio	300	0
security system	180	0
dvd player/ vcr	100	0
common light bulb	75	0

NOTE: The above wattage figures are estimates. Try to check the wattage listed on your electrical device before consulting this chart.

Figure 8- Estimated wattage requirements of common electrical devices.

Once you have determined what electrical devices you will be powering with the generator, connect these devices according to the following procedure:

1. Plug in each electrical device with the device turned off. **NOTE:** Be sure to attach appliances to the correct receptacle (outlet). Connect standard 120 Volt, single phase, 60 Hz loads **only** to the 120 Volt receptacles. Connect 120/240 Volt, single phase, 60Hz loads with a NEMA L14-30 plug **only** to the 120/240 Volt receptacle See Figure 9 for a depiction of each of these receptacles.
2. Check that the pilot light are lit under the engine switch.

**⚠ CAUTION:** Do not connect 50Hz or 3-phase loads to the generator.

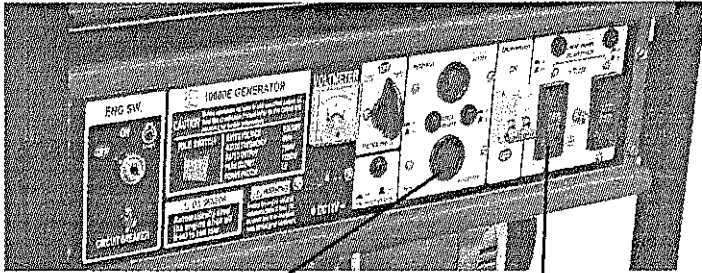

120/240V Receptacle

120V AC GFCI Receptacle

Figure 9- Receptacles available on the generator

#### SOME NOTES ABOUT POWER CORDS

Long or thin cords can drain the power provided to an electrical device by the generator. When using such cords, allow for a slightly higher rated wattage requirement by the electrical device. See Figure 10 for recommended cords based on the power requirement of the electrical device.

Device Requirements			Max. Cord Length (ft) by Wire Gauge				
Amps	Watts (120V)	Watts (240 V)	#8 wire	#10 wire	#12 wire	#14 wire	#16 wire
5	600	1200	NR	500	300	200	125
7.5	900	1800	NR	350	200	125	100
10	1200	2400	NR	250	150	100	50
15	1800	3600	NR	150	100	65	NR
20	2400	4800	175	125	75	50	NR
25	3000	6000	150	100	60	NR	NR
30	3600	7200	125	65	NR	NR	NR

\*NR= not recommended

Figure 10- Maximum Extension Cord Lengths by Power Requirement

## STOPPING THE GENERATOR

To stop the generator:

1. Turn off, then unplug all connected electrical devices.
2. Allow the generator to run for several more minutes with no electrical devices connected. This helps stabilize the temperature of the generator.
3. Turn the engine switch key to the "off" position. Remove the key.
4. Turn the fuel valve to the "off" position.

**⚠ WARNING:** Allow the generator to cool for several minutes before touching areas that become hot during use.

**⚠ CAUTION:** Allowing gas to sit in the generator tank for long periods of time without use can make it difficult to start the generator in the future. Never store generator for extended periods of time with fuel in the tank.

## MAINTENANCE / CARE

Proper routine maintenance of your generator will help prolong the life of your machine. Please perform maintenance checks and operations according to the schedule in figure 11.

**⚠ CAUTION:** Never perform maintenance operations while the generator is running.

Recommended Maintenance Schedule

		each use	first month of use or first 20 hrs	every 3 months or 50 hrs	every 6 months or 100 hrs	every year or 300 hrs	As necessary
Engine oil	check level	x					
	Replace		x	x			x
Air cleaner	check	x					
	Clean			x			
fuel filter cup	Clean				x		
spark plug	check/ clean				x		
gas tank	check gas level	x					
	Clean					x	

Figure 11- Recommended maintenance schedule

### Cleaning the Generator

Always try to use your generator in a cool dry place. In the event your generator becomes dirty you may clean the exterior with one or more of the following:

- a damp cloth
- a soft brush
- a vacuum



pressurized air

Never clean your generator with a bucket of water or a hose. Water can get inside the working parts of the generator and cause a short circuit or corrosion.

### Checking the Oil

The generator is equipped with an automatic shutoff to protect it from running on low oil. Nonetheless, you should check the oil level of the generator before each use to ensure that the generator crankcase has a sufficient amount. To check the oil level:

1. Make sure the generator is on a level surface.
2. Unscrew the oil filler/dipstick cap (see figure 12).
3. With a dry cloth, wipe the oil off of the stick on the inside of the cap.
4. Insert the dipstick as if you were replacing the cap and then remove again. There should now be oil on the stick. If there is no oil on the stick, or oil only at the very end of the stick, you should add oil until the engine crankcase is filled. See "Changing/ Adding Oil" in this section.
5. Be sure to reinstall the cap when finished checking the oil.

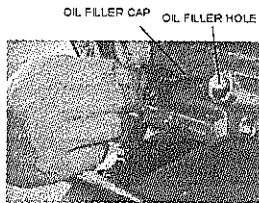

Figure 12- Checking the oil

### Changing/ Adding Oil

You should check the oil level of your generator according to the maintenance schedule in figure 11. When the oil level is low you will need to add oil until the level is sufficient to run the generator. The oil capacity of your generator engine is 37 fluid oz.

It is necessary to drain the oil from the crankcase after 50 hrs of use, or if it has become contaminated with water or dirt. In this case, you can drain the oil from the generator according to the following steps:

1. Place a bucket underneath the generator to catch oil as it drains.
2. Using a hex wrench, unscrew the oil drain plug, which is located on the crankcase underneath the oil filler/dipstick cap (see figure 13). Allow all the oil to drain from the generator.
3. Replace the oil drain plug and tighten with a hex wrench.

To add oil to the crankcase, follow these steps:

1. Make sure the generator is on a level surface.

2. Unscrew the oil filler/dipstick cap from the engine as shown in figure 12 above.
3. Using a funnel, add 30W, 4-stroke engine oil. When full, the oil level should come close to the top of the oil fill opening (see figure 14).

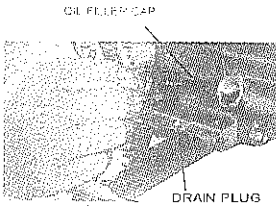

Figure 13- Draining oil

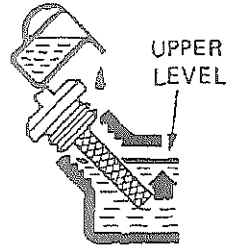

Figure 14- Adding oil

**NOTE:** Never dispose of used motor oil in the trash or down a drain. Please call your local recycling center or auto garage to arrange oil disposal.

### Air Cleaner Maintenance

Routine maintenance of the air cleaner helps maintain proper air flow to the carburetor. Occasionally check that the air cleaner is free of excessive dirt.

1. Unscrew the four bolts at the top and bottom of the air cleaner cover (see figure 15).
2. Remove the sponge-like elements from the casing.
3. Wipe the dirt from inside the empty air cleaner casing.
4. Wash the sponge-like elements in household detergent and warm water. Allow to dry.
5. Soak the dry elements in engine oil. Squeeze out any excess oil.
6. Replace the sponge-like elements in the air cleaner casing and replace the cover.

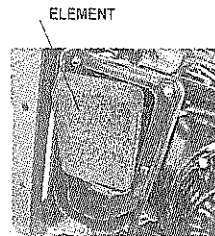
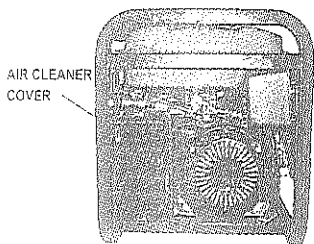

Figure 15- Removing the air cleaner casing.

### Fuel Filter Cup Cleaning

The fuel filter cup is a small well underneath the fuel valve. It helps to trap dirt and water that may be in your fuel tank before it can enter the engine. To clean the fuel filter cup:

1. Turn the fuel valve to the "off" position.
2. Unscrew the fuel filter cup from the fuel valve using a wrench. Turn the valve toward you to unscrew (see figure 16).
3. Clean the cup of all sediment using a rag or brush.
4. Reinstall the fuel filter cup.

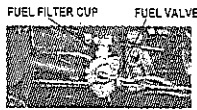

Figure 16- Removing the Fuel Filter Cup

### Spark Plug Maintenance

The spark plug is important for proper engine operation. A good spark plug should be intact, free of deposits, and properly gapped. To inspect your spark plug:

1. Pull on the spark plug cap to remove it.
2. Unscrew the spark plug from the generator using the spark plug wrench included with this product (see figure 17). Visually inspect the spark plug. If it is cracked or chipped, discard and replace with a new spark plug. Measure the plug gap with a gauge (see figure 18). The gap should be 0.7-0.8mm (0.028-0.031 in.).
3. If you are re-using the spark plug, use a wire brush to clean any dirt from around the spark plug base and then re-gap the spark plug.
4. Screw the spark plug back into its place on the generator using the spark plug wrench. Replace the spark plug cap.

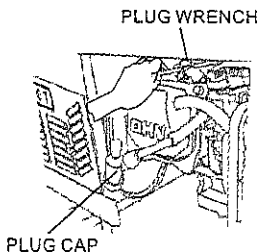

Figure 17- Removing the spark plug

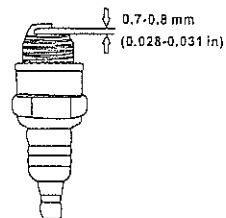

Figure 18- Measuring the spark plug gap

### Emptying the Gas Tank

Before storing your generator for extended periods of time, you should drain your generator of gasoline. To drain the generator of gas:

1. Turn the fuel valve to the "off" position.
2. Remove the fuel filter cup (see "Fuel Filter Cup Cleaning" earlier in this section).
3. Empty the fuel filter cup of any fuel.
4. With a receptacle underneath the generator to catch the gas, turn the fuel valve to the "on" position. Drain all the gas from the generator.
5. Turn the fuel valve to the "off" position.
6. Replace the fuel filter cup.
7. Store the emptied gasoline in a suitable place.

**⚠ CAUTION:** Do not store fuel from one season to another.

### STORAGE / TRANSPORT PROCEDURES

**⚠ CAUTION:** Never place any type of storage cover on the generator while it is still hot.

When transporting or storing your generator for extended periods of time:

- Empty the gas tank (see "Emptying the Gas Tank" in the "Maintenance" section).
- Disconnect the spark plug.
- Do not obstruct any ventilation openings.
- Keep the generator in a cool dry area.

## SPECIFICATIONS

### Generator

#### AC Output

	Model 6500E	Model 8000E	Model 10000E
Power	5500 W	5500 W	7000 W
Rated Voltage	120/240 /220/380/400		
Rated Frequency	50/60 Hz		
Phase	Single/Three		
Dimensions(in):	length=27 width= 20 height=22.8	length=28.0 width= 20.9 height=23.2	length= 28.8 width= 24.0 height= 26.8
Net Weight	207lbs	211lbs	222 lbs
Gross Weight	218lbs	222lbs	240lbs

#### Engine

	Model 188FE	Model 188FE	Model 190FE
Engine type	4-stroke, OHV , single cylinder with forced air cooling system	4-stroke, OHV , single cylinder with forced air cooling system	4-stroke, OHV, single cylinder with forced air cooling system
Ignition system	non-contact transistor	non-contact transistor	non-contact transistor
Displacement	389 cc	389 cc	420 cc
Fuel tank capacity:	25 L (6.6 US gal.)	32 L (8.5 US gal.)	46 L ( 12 US gal.)
Oil capacity	1.1 L (37 fl oz.)	1.1 L (37 fl oz.)	1.1 L (37 fl oz.)
Run time on 50% load	8 hrs	11 hrs	16 hrs

## TROUBLESHOOTING

Problem	Cause	Solution
Engine will not start	Engine switch is set to "off".	Set engine switch to "on".
	Fuel valve is turned to "closed".	Turn fuel valve to "open" position.
	Choke is open.	Close the choke
	Engine is out of gas.	Add gas.
	Engine is filled with contaminated or old gas.	Change the gas in the engine.
	Spark plug is dirty.	Clean spark plug.
	Spark plug is broken.	Replace spark plug.
	Generator is not on level surface.	Move generator to a level surface to prevent low oil shutdown from triggering.
	Oil is low.	Add or replace oil.
Engine runs but there is no electrical output	Circuit reset button is off.	Wait for 2 minutes and push the circuit reset button to the "on" position.
	Bad connecting wires/cables.	If you are using an extension cord, try a different one.
	Bad electrical device connected to generator.	Try connecting a different device.
Generator runs but does not support all electrical devices connected.	Generator is overloaded	Perform these steps: 1. Turn off all electrical devices. 2. Unplug all electrical devices. 3. Turn off generator. 4. Wait several minutes. 5. Restart generator. 6. Try connecting fewer electrical loads to the generator.
	Short in one of the connected devices.	Try disconnecting any faulty or short-circuited electrical loads.
	Air cleaner is dirty.	Clean or replace air cleaner.



